

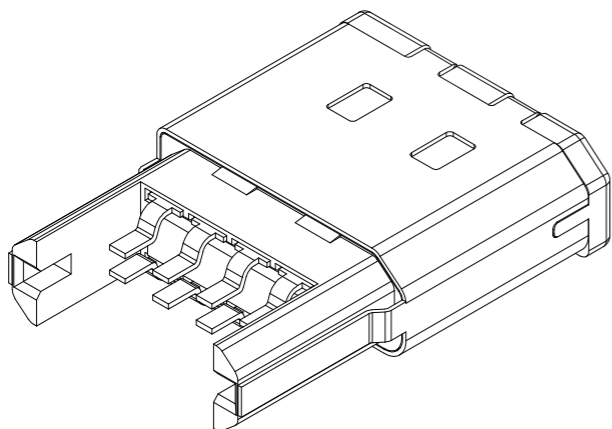

RoHS2.0
Compliant

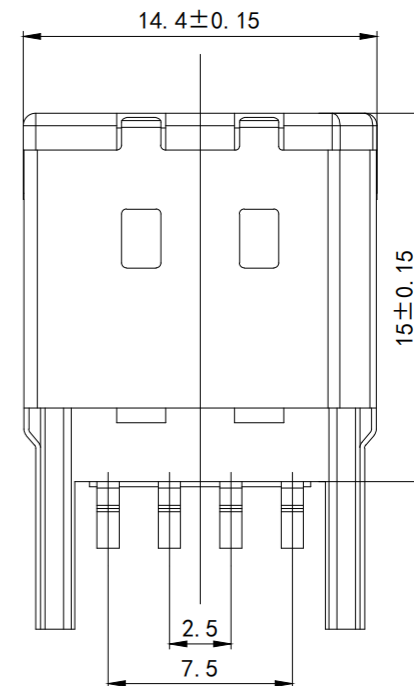
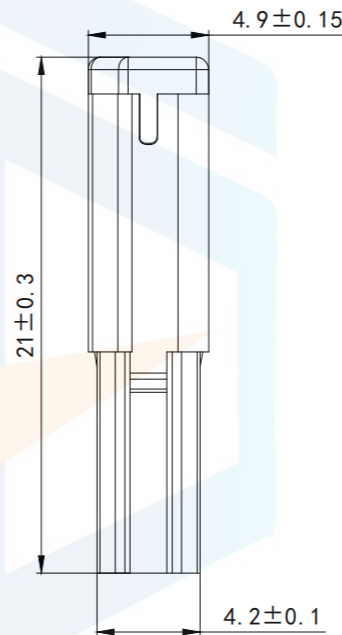
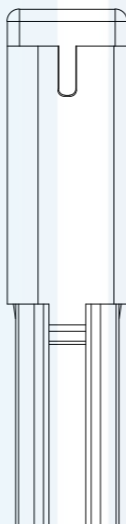
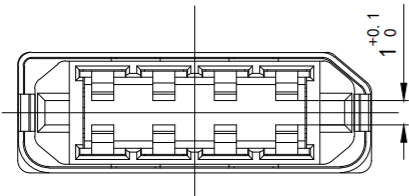
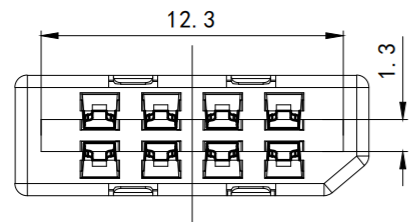
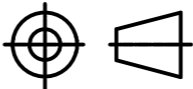

| | | | | | |
|---|-------|---|--|-----------------------------|-----------------------|
| TOLERANCE | |  | 东莞市恒祺电子科技有限公司 | | |
| X. XXX | ±0.05 | | Dongguan Hengqi Electronic Technology Co., Ltd | | |
| X. XX | ±0.15 | https://www.hq-dz.com | | | phone: 15812872448 |
| X. X | ±0.20 | TITLE: | | PART NO: USB2.0-A08P | |
| X. | ±0.30 | USB DP8P单C角 | | DRAWING NO: 14.4*15*4.9 | |
| ANGLE | ±5.0° | PROTECTON | | DRAWN: | DATE: 18-10-08 |
|  | | | | CHECKED: | DATE: 18-10-08 |
| | | | | APPROVED: | DATE: 18-10-08 |
| | | | | UNIT: | mm |
| | | | | SCALE: | FULL |
| | | | | SIZE: | A4 |