

RoHS2.0
Compliant

H	
4.3	4.5
5.0	5.5
6.0	6.5
7.0	7.5
8.0	8.5
9.0	9.5

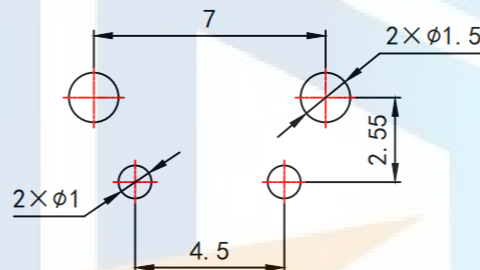
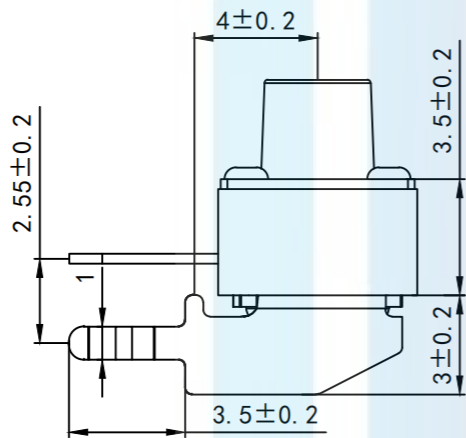
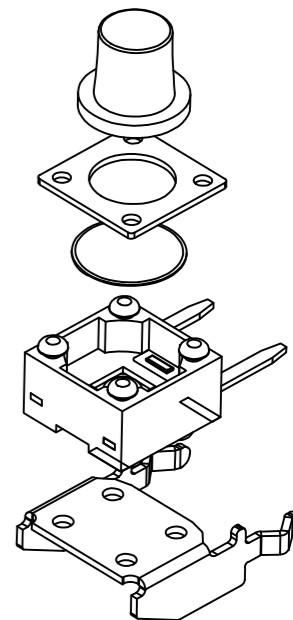
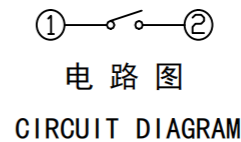
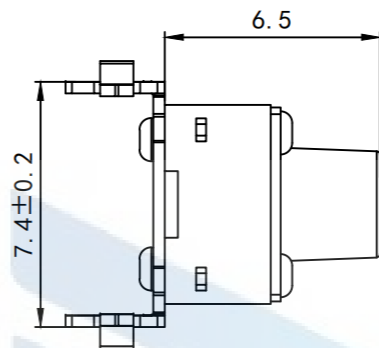
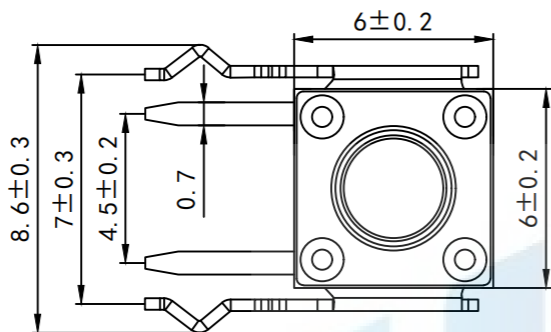

PCB. 焊接图
PCB. WELDING DRAWING

Key Technical Specifications:

1. Rating: 50mA DC12V
2. Contact resistance: $\leq 50m\Omega$
3. Operating force: $160 \pm 40gf$
4. Itinerary: $0.25 \pm 0.1mm$
5. Insulation resistance: $\geq 100M\Omega$
6. Electrical strength: 250V 50HZ 1Min.
7. life span: 50000&100,000 Cycles

TOLERANCE

X. XXX	± 0.05
X. XX	± 0.15
X. X	± 0.20
X.	± 0.30
ANGLE	$\pm 5.0^\circ$

PROTECTON

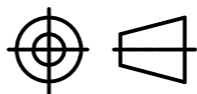

东莞市恒祺电子科技有限公司

Dongguan Hengqi Electronic Technology Co., Ltd

<https://www.hq-dz.com>

phone: 15812872448

TITLE:

轻触开关

PART NO: HQ-TS-D012

DRAWING NO: 6*6*H后支架

DRAWN:

DATE:

18-10-08

UNIT:
mm

CHECKED:

DATE:

18-10-08

SCALE:
FULL

APPROVED:

DATE:

18-10-08

SIZE:
A4