

RoHS2.0
Compliant

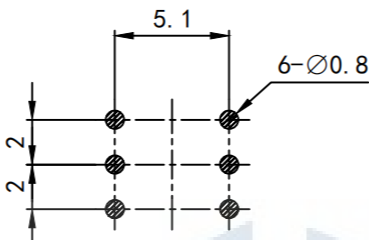
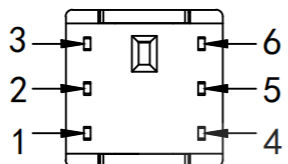
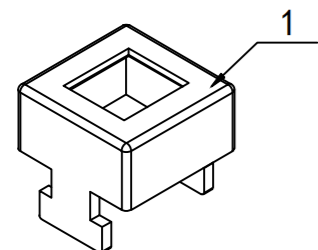

P. C. B LAYOUT

SPECIFICATION:

1. Rated voltage :DC 50V 0.3A
2. Contact resistance :30MΩ MAX less than 30Mω
3. Insulation resistance :100MΩ MIN 100 megohm or more
4. Compressive strength :AC500V(50/60Hz) 1 minute sensitivity current is 0.5mA
5. Operating temperature: -16°C±60°C
6. Mechanical life: 10,000 cycles

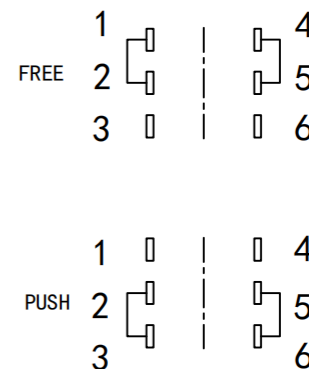
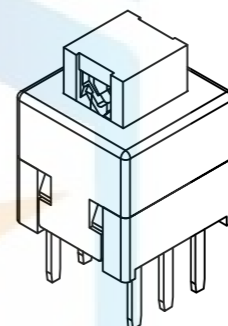
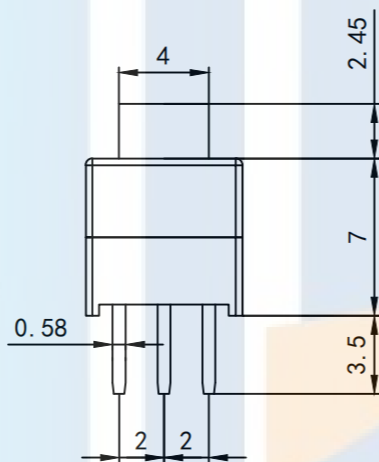
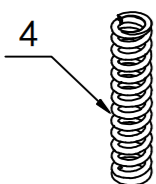
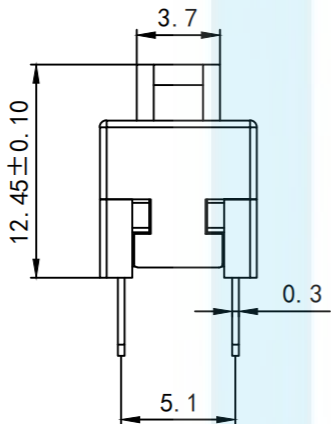
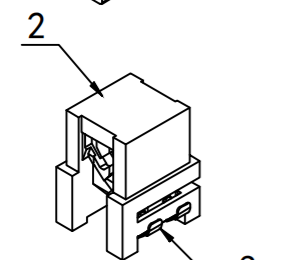

CIRCUIT DIAGRAM

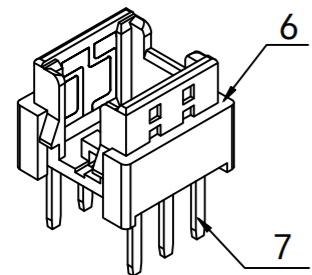
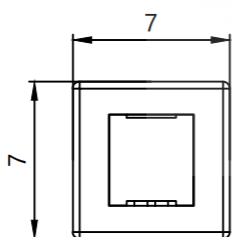
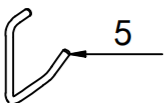

TOLERANCE

X. XXX	±0.05
X. XX	±0.15
X. X	±0.20
X.	±0.30
ANGLE	±5.0°

PROTECTON

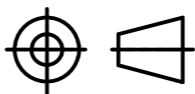

东莞市恒祺电子科技有限公司
Dongguan Hengqi Electronic Technology Co., Ltd

<https://www.hq-dz.com>

phone:15812872448

TITLE:

按键开关
自(无)锁

PART NO:7*7双排6脚平头

DRAWING NO:7*7*12.45

DRAWN:

CHECKED:

APPROVED:

DATE:

DATE:

DATE:

18-10-08

18-10-08

18-10-08

UNIT:
mm

SCALE:
FULL

SIZE:
A4