

RoHS2.0
Compliant ✓

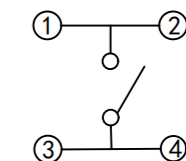

Circuit Diagram

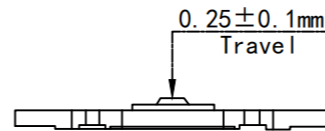
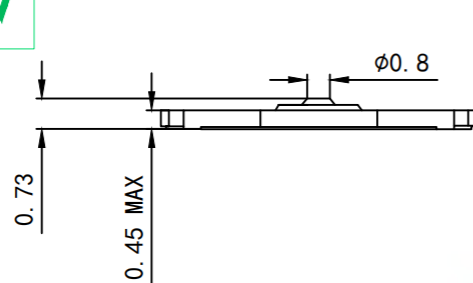
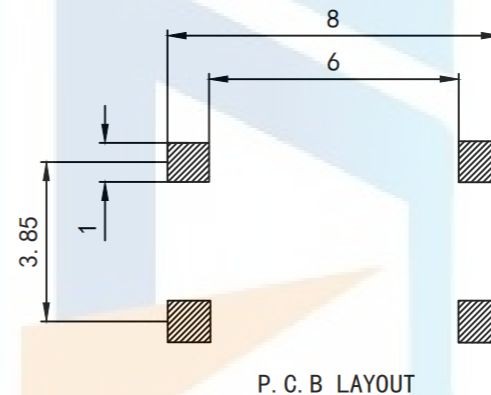
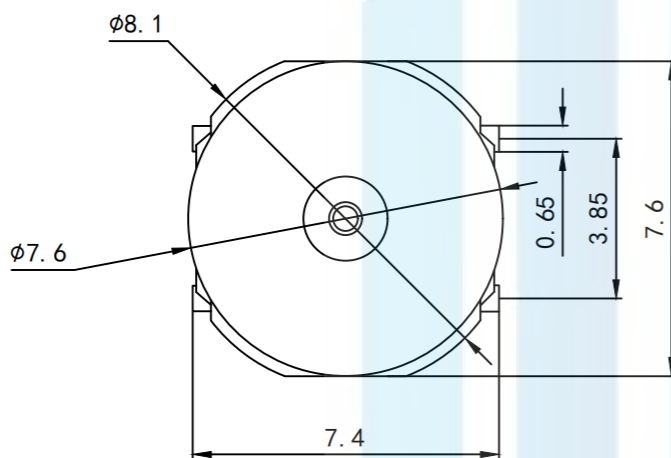

P. C. B LAYOUT

Remarks:

1. Rated current、Voltage: DC 12V 50mA
2. Contact resistance: 100mQ
3. Insulation resistance: >100MQ
4. The intensity of operations: 250±50gf
5. Life requirements: 50000次
6. Withstand voltage: AC 250V 1分钟
7. All materials comply with RoHS standards

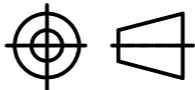
TOLERANCE X. XXX ±0.05 X. XX ±0.15 X. X ±0.20 X. ±0.30 ANGLE ±5.0°		 东莞市恒祺电子科技有限公司 Dongguan Hengqi Electronic Technology Co., Ltd	
		https://www.hq-dz.com phone:15812872448	
		TITLE: 薄膜轻触开关	PART NO: HQ-TS-C022
		DRAWING NO: 74*7.6*0.73	
PROTECTON 		DRAWN:	DATE: 18-10-08
		CHECKED:	DATE: 18-10-08
		APPROVED:	DATE: 18-10-08
			UNIT: mm
			SCALE: FULL
			SIZE: A4